

# Special I/O Module

## RIO3-CU24L User Manual

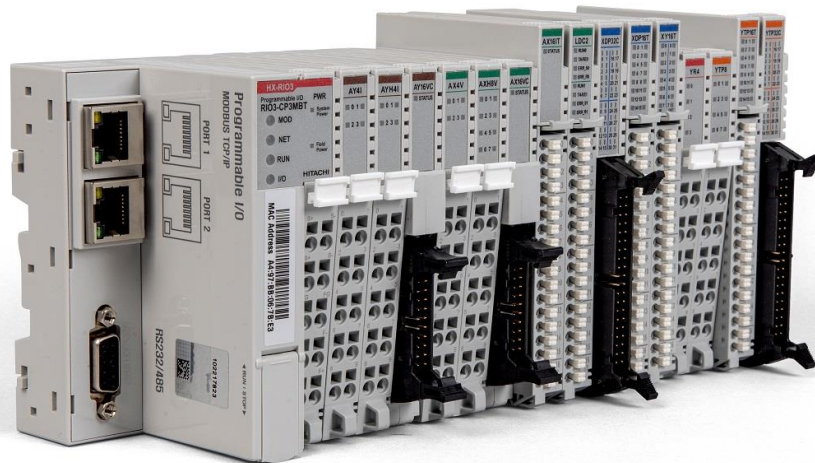

Version 1.00

DOCUMENT REVISION				
REV	PAGE	REMARKS	DATE	EDITOR
1.00	New Document		06 NOV 2020	(OPR), (PF)

## Table of Contents

1	Important Notes .....	4
1.1	Safety Instruction .....	5
1.1.1	Symbols .....	5
1.1.2	Safety Notes .....	5
1.1.3	Certification .....	5
2	Specification .....	6
2.1	RIO3-CU24L .....	6
2.1.1	Wiring Diagram .....	6
2.1.2	LED Indicator .....	7
2.1.3	Channel Status LED .....	7
2.1.4	Specification.....	8
2.1.5	Mapping data into the image table.....	9
2.1.6	Configuration Parameter Data – 4byte .....	11
3	Environment Specification .....	12
4	Dimension.....	13
4.1	10-Pts. Spring Type .....	13
5	Mounting.....	14
5.1	I/O Inserting and Removing Devices .....	14
5.2	RTB (Removable Terminal Block) .....	15
6	G-Bus Pin Description .....	16
7	APPENDIX A .....	17
7.1	Product List .....	17
7.2	Glossary.....	18

## 1 Important Notes

Solid state equipment has operational characteristics differing from those of electromechanical equipment. Safety Guidelines for the Application, Installation and Maintenance of Solid-State Controls describes some important differences between solid state equipment and hard-wired electromechanical devices.

Because of this difference, and because of the wide variety of uses for solid state equipment, all persons responsible for applying this equipment must satisfy themselves that each intended application of this equipment is acceptable.

In no event will HITACHI be responsible or liable for indirect or consequential damages resulting from the use or application of this equipment.

The examples and diagrams in this manual are included solely for illustrative purposes. Because of the many variables and requirements associated with any installation, HITACHI cannot assume responsibility or liability for actual use based on the examples and diagrams.

### Warning!



- ✓ **If you don't follow the directions, it could cause a personal injury, damage to the equipment or explosion**
- ✓ Do not assemble the products and wire with power applied to the system. Else it may cause an electric arc, which can result into unexpected and potentially dangerous action by field devices. Arching is explosion risk in hazardous locations. Be sure that the area is non-hazardous or remove system power appropriately before assembling or wiring the modules.
- ✓ Do not touch any terminal blocks or IO modules when system is running. Else it may cause the unit to an electric shock or malfunction.
- ✓ Keep away from the strange metallic materials not related to the unit and wiring works should be controlled by the electric expert engineer. Else it may cause the unit to a fire, electric shock or malfunction.

### Caution!

- ✓ **If you disobey the instructions, there may be possibility of personal injury, damage to equipment or explosion. Please follow below Instructions.**
- ✓ Check the rated voltage and terminal array before wiring. Avoid the circumstances over 50°C of temperature. Avoid placing it directly in the sunlight.
- ✓ Avoid the place under circumstances over 85% of humidity.
- ✓ Do not place Modules near by the inflammable material. Else it may cause a fire.
- ✓ Do not permit any vibration approaching it directly.
- ✓ Go through module specification carefully, ensure inputs, output connections are made with the specifications. Use standard cables for wiring.
- ✓ Use Product under pollution degree 2 environment.

## 1.1 Safety Instruction

### 1.1.1 Symbols

<p><b>DANGER</b></p> 	<p>Identifies information about practices or circumstances that can cause an explosion in a hazardous environment, which may lead to personal injury or death property damage, or economic loss.</p>
<p><b>IMPORTANT</b></p>	<p>Identifies information that is critical for successful application and understanding of the product.</p>
<p><b>ATTENTION</b></p> 	<p>Identifies information about practices or circumstances that can lead to personal injury, property damage, or economic loss.</p> <p>Attentions help you to identity a hazard, avoid a hazard, and recognize the consequences</p>

### 1.1.2 Safety Notes

<p><b>DANGER</b></p> 	<p>The modules are equipped with electronic components that may be destroyed by electrostatic discharge. When handling the modules, ensure that the environment (persons, workplace and packing) is well grounded. Avoid touching conductive components, RBUS Pin.</p>
--	--

### 1.1.3 Certification

UL Listed Industrial Control Equipment, certified for U.S.

See UL File E196687

CE Certificate

EN 61000-6-2; Industrial Immunity

EN 61000-6-4; Industrial Emissions

Reach, RoHS (EU, CHINA), EAC

## 2 Specification

### 2.1 RIO3-CU24L

#### 2.1.1 Wiring Diagram

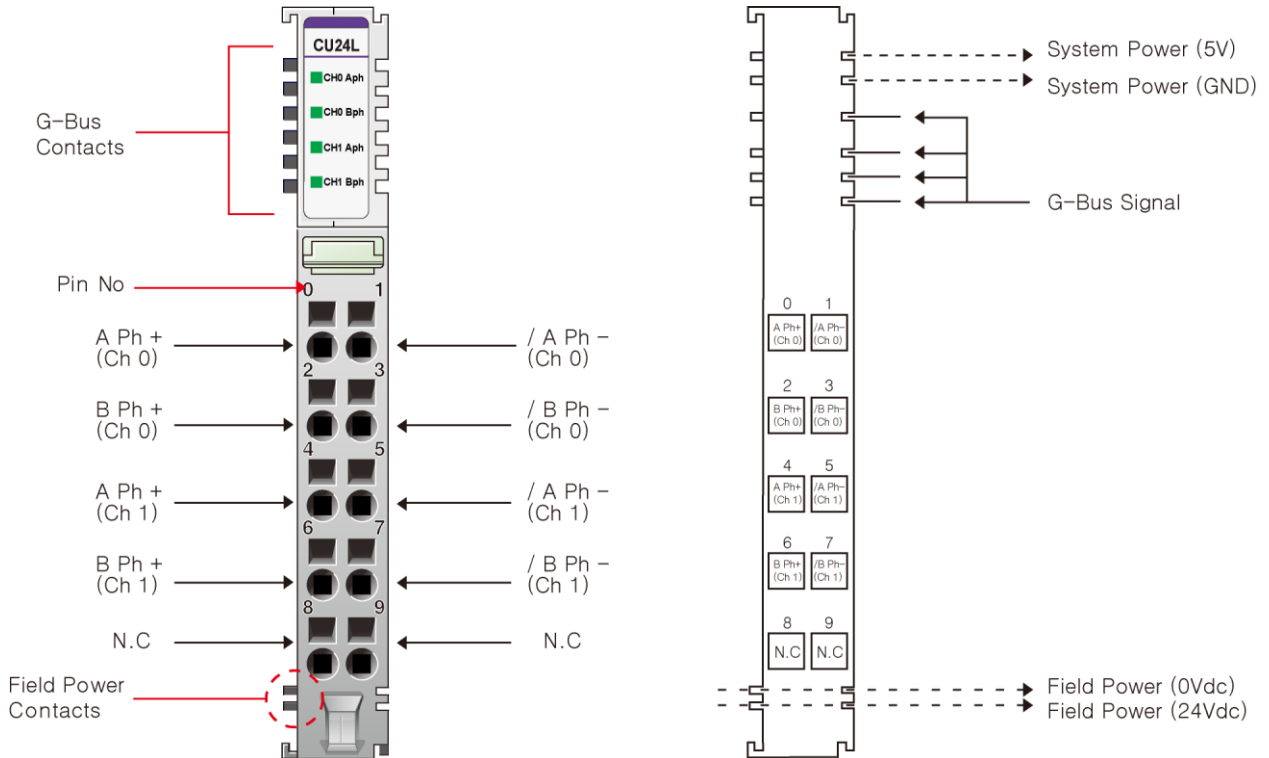

Pin No.	Signal Description	Signal Description	Pin No.
0	A Ph Input+ Ch# 0	A Ph Input- Ch# 0	1
2	B Ph Input+ Ch# 0	B Ph Input- Ch# 0	3
4	A Ph Input+ Ch# 1	A Ph Input- Ch# 1	5
6	B Ph Input+ Ch# 1	B Ph Input- Ch# 1	7
8	Shield	Shield	9

### 2.1.2 LED Indicator



LED No.	LED Function / Description	LED Color
0	Aph Input Ch# 0	Green
1	Bph Input Ch# 0	Green
2	Aph Input Ch# 1	Green
3	Bph Input Ch# 1	Green

### 2.1.3 Channel Status LED

Status	LED is	To indicate
No Signal	Off	Normal Operation
On Signal	Green	Normal Operation

## 2.1.4 Specification

Items	Specification
<b>Input specification</b>	
Number of channels	2 channels - Encoder, High Speed Counter, Frequency measurement Pulse width & Period measurement
Indicators	4 green terminal input
Input voltage	24Vdc nominal (Max 28.8Vdc)
Input current	3mA @ 24Vdc
Min on-state voltage	≥16.5Vdc
Input frequency	0~750kHz Encoder Mode 0~300kHz Counting Mode
Counting mode	1-Input Mode: Up,Down 2-Input Mode: Encoder 4x, Encoder 2x, Up/Inhibit, Up/Reset, Down/Inhibit, Down/Reset, UP/Down, Clock/Direction, Frequency Measurement, Pulse Width & Period measurement
Counter size	32bit-wide/channel
<b>General specification</b>	
Power dissipation	Max. 65mA @ 5Vdc
Isolation	I/O to Logic: Photocoupler isolation
UL field power	Supply Voltage: 24Vdc nominal, Class 2
Field power	Not used Field power bypass to next expansion module
Wiring	I/O Cable Max. 2.0mm <sup>2</sup> (AWG 14)
Torque	0.8Nm (7 lb-in)
Weight	60g
Module size	12mm x 99mm x 70mm
<b>Environment condition</b>	<b>Refer to '1. Environment Specification'</b>



## 2.1.5 Mapping data into the image table

### Input Image Data – 8byte

Byte	Bit 7	Bit 6	Bit 5	Bit 4	Bit 3	Bit 2	Bit 1	Bit 0
0				Counter Value Ch#0 LL				
1				Counter Value Ch#0 LH				
2				Counter Value Ch#0 HL				
3				Counter Value Ch#0 HH				
4				Counter Value Ch#1 LL				
5				Counter Value Ch#1 LH				
6				Counter Value Ch#1 HL				
7				Counter Value Ch#1 HH				

- Each channel has 4-byte Input
- Counter value represents counter, frequency (Hz), pulse width (0.1usec) or pulse period (0.1usec).

### Output Image Data – 2byte

Byte	Bit 7	Bit 6	Bit 5	Bit 4	Bit 3	Bit 2	Bit 1	Bit 0
0	CR 0	CS 0	--	--		Count Mode ch#0		
1	CR 1	CS 1	--	--		Count Mode ch#1		

- CR 0,1: Counter Reset for Ch#0, Ch#1
- CS 0,1: Counter Stop (Inhibit Input) for Ch#0, Ch#1
- Count Mode Ch#0,1: Count Mode for Ch#0, Ch#1 respectively

**Count Mode Ch#0, Ch#1**

Value	Count Mode	Description
B' 0000 (0x0)	Up	Up Counter - Aph Input acts as Up Clock - Bph Input is not used
B' 0001 (0x1)	Down	Down Counter - Aph Input acts as Down Clock - Bph Input is not used
B' 0010 (0x2)	-	-
B' 0011 (0x3)	-	-
B' 0100 (0x4)	Up Clock & Inhibit	Up Counter with Inhibit - Aph Input acts as Up Clock Input - Bph Input acts as Inhibit function for Up Clock Input
B' 0101 (0x5)	Up Clock & Reset	Up Counter with Reset - Aph Input acts as Up Clock Input - Bph Input acts as Reset function to Counter
B' 0110 (0x6)	Down Clock & Inhibit	Down Counter with Inhibit - Aph Input acts as Down Clock Input - Bph Input acts as Inhibit function for Down Clock Input
B' 0111 (0x7)	Down Clock & Reset	Down Counter with Reset - Aph Input acts as Down Clock Input - Bph Input acts as Reset function to Counter
B' 1000 (0x8)	Up Clock & Down Clock	Up & Down Counter - Aph Input acts as Up Clock Input - Bph Input acts as Down Clock Input
B' 1001 (0x9)	Clock & Direction	Up & Down with Direction - Aph Input acts as Clock Input - Bph Input acts as Direction Input ( Low = Up Count, High = Down Count )
B' 1010 (0xA)	Encoder 1x (*1)	Encoder 1x - Aph Input acts as Encoder's A phase Input - Bph Input acts as Encoder's B phase Input
B' 1010 (0xB)	Encoder 2x	Encoder 2x - Aph Input acts as Encoder's A phase Input - Bph Input acts as Encoder's B phase Input
B' 1011 (0xC)	Encoder 4x	Encoder 4x - Aph Input acts as Encoder's A phase Input - Bph Input acts as Encoder's B phase Input
B' 1101 (0xD)	Frequency Measurement 1sec Update (*2)	Simple Frequency Measurement, updated by 1sec, Hz Unit - Aph Input acts as Frequency Input - Bph Input is not used

B' 1110 ( 0xE )	Pulse Width Measurement (*3)	Simple Pulse Width Measurement, 0.1usec Unit - Pulse Width(32bit), if 1234, then Pulse High(On) width is 123.4usec (*3) - Aph Input acts as Pulse Input - Bph Input is not used
B' 1111 ( 0xF )	Pulse Width & Period Measurement (*4)	Simple Pulse Width & Period Measurement, 0.1usec Unit, - Available in case of Pulse Input >= 200Hz(<= 2.5msec, Pulse On Width) - Pulse Width(16bit, Low Word) + Pulse Period(16bit, High Word) (*4) - Aph Input acts as Pulse Input - Bph Input is not used

- Frequency Range of the Encoder x1 mode is the same as the counting mode.
- Frequency, B'1101 (0xD) can't be used with other channel's Count Mode = 0x0, 0x1, 0x4 ~ 0x9
- Pulse Width, B'1110 (0xE) measures Aph Input's High (On) Pulse Width(32bit) in 0.1usec unit.
- Pulse Width & Period, B'1111 (0xF) measures Aph's Pulse High (On) Width (16bit) & Period (16bit) in 0.1usec unit.

### 2.1.6 Configuration Parameter Data – 4byte

Byte	Bit 7	Bit 6	Bit 5	Bit 4	Bit 3	Bit 2	Bit 1	Bit 0
0					Reserved			
1					Reserved			
2					Reserved			
3					Reserved			

### 3 Environment Specification

Environmental specification	
Operating Temperature	-20°C ~ 70°C
UL Temperature	-20°C ~ 60°C
Storage Temperature	-40°C ~ 85°C
Relative Humidity	5% ~ 90% non-condensing
Mounting	DIN rail
General specification	
Shock Operating	IEC 60068-2-27: 2008/15g, 11ms
Vibration Resistance	Based on IEC 60068-2-6 DNVGL-CG-0039: Vibration Class B, 4g
Industrial Emissions	EN61000-6-4: 2007 +A1: 2011
Industrial Immunity	EN61000-6-2: 2005
Installation Position	Vertical and horizontal installation is possible
Product Certifications	CE, UL, EAC

## 4 Dimension

### 4.1 10-Pts. Spring Type

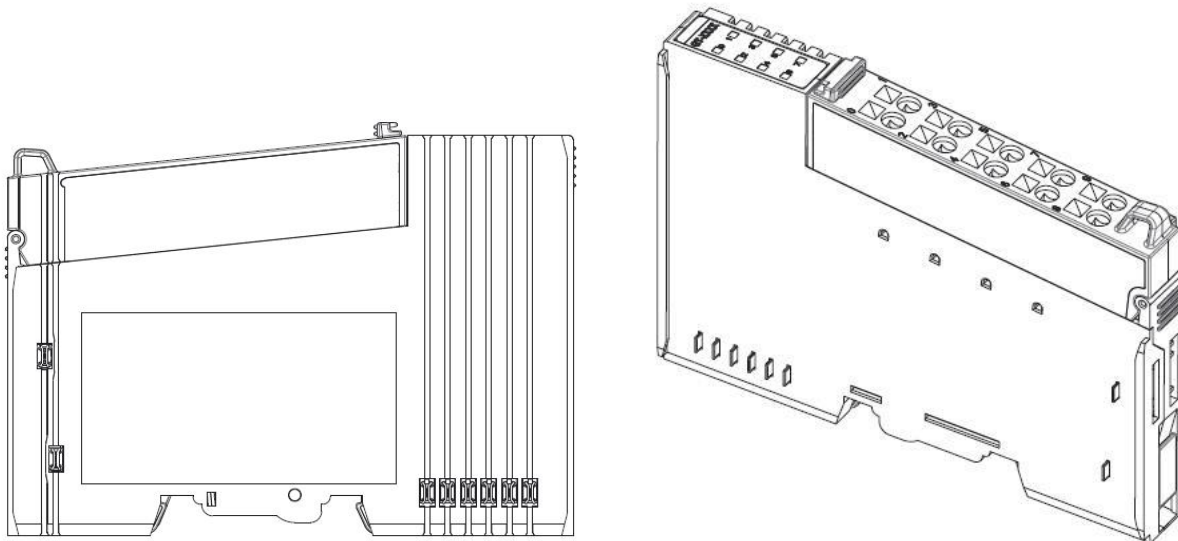
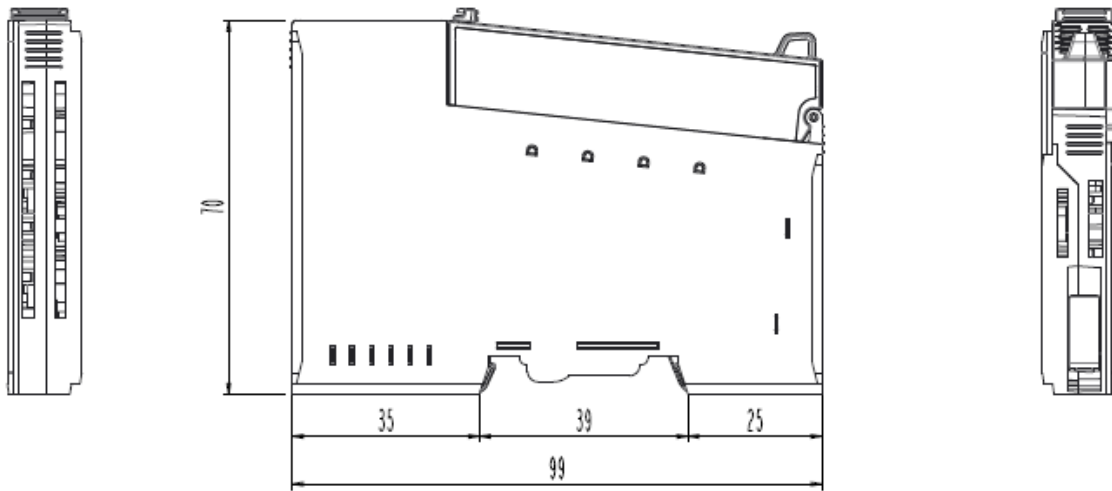

*Dimensions in mm*

## 5 Mounting

### Caution!

#### Hot surface!

The surface of the housing can become hot during operation. If the device was operated at high ambient temperatures, allow it to cool off before touching it.

### Notice!

#### Perform work on devices only if they are de-energized!

Working on energized devices can damage them. Therefore, turn off the power supply before working on the devices.

### 5.1 I/O Inserting and Removing Devices

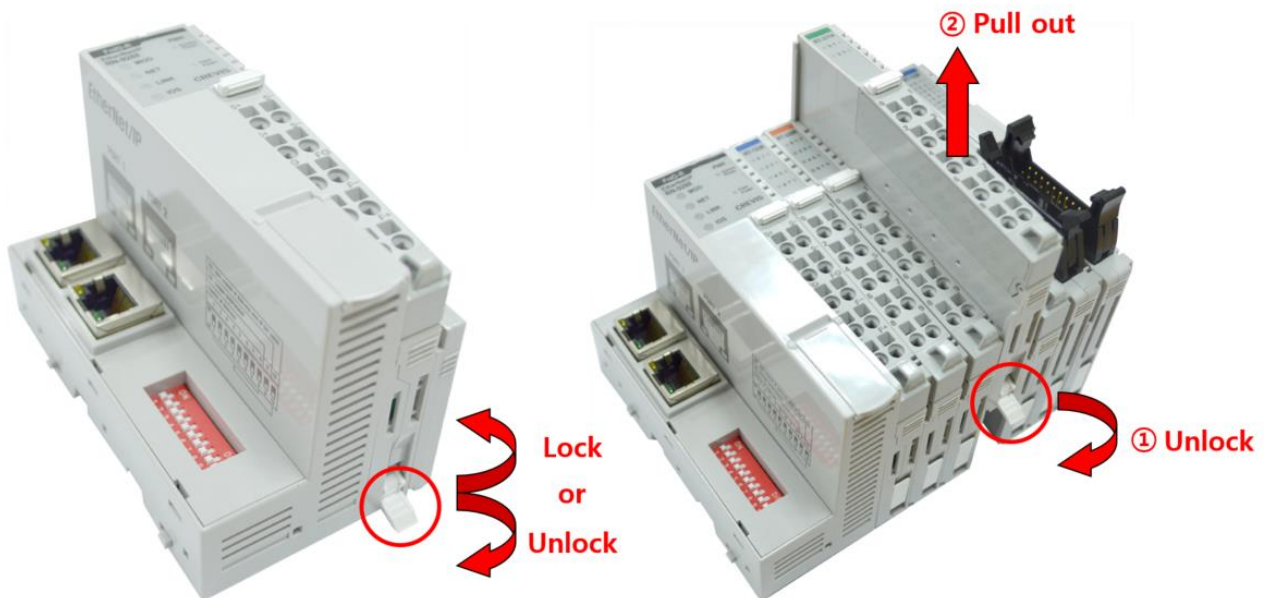

As above figure in order to safeguard the RIO3-Module from jamming, it should be fixed onto the DIN rail with locking lever. To do so, fold on the upper of the locking lever.

To pull out the RIO3-Module, unfold the locking lever as below figure.

## 5.2 RTB (Removable Terminal Block)

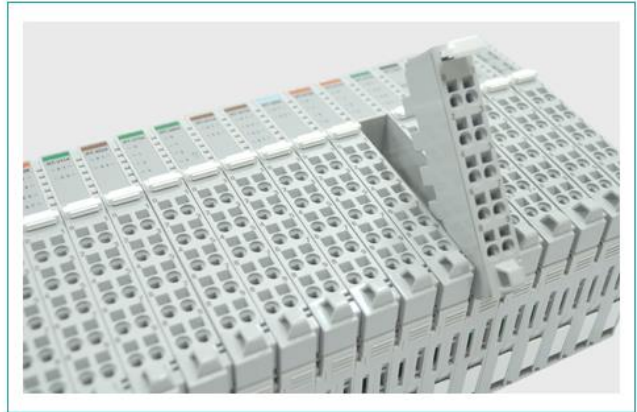
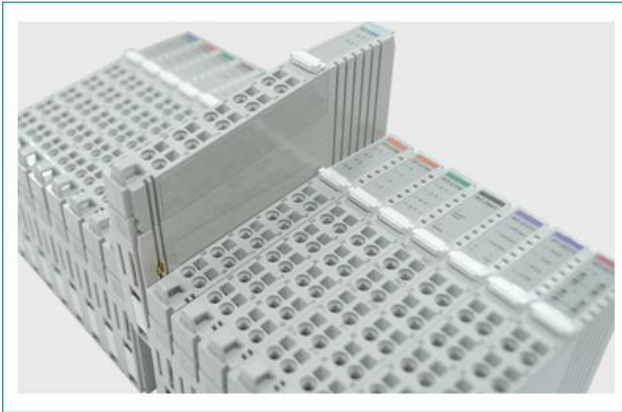

Whole terminal block can be combined and removed for the convenience of its maintenance.  
There is a locking switch on the RTB for the easy combination and easy removal.  
Easy combination and easy removal for IO modules on the din rail through One Touch Locking Switch.

## 6 G-Bus Pin Description

Communication between the Network Adapter and the expansion module as well as system / field power supply of the bus modules is carried out via the internal bus. It is comprised of 6 data pin and 2 field power pin.



\*Please refer to the table below regarding the pin description from P1 to P8.

No.	Description
P1	Field Power (VCC)
P2	Field Power (GND)
P3	GBUS CLK
P4	GBUS MISO
P5	GBUS MOSI
P6	GBUS Token
P7	System Power (GND)
P8	System Power (VCC)

**DANGER**



Do not touch data and field power pins in order to avoid soiling and damage by ESD noise.



## 7 APPENDIX A

### 7.1 Product List

No.	RIO3-Number	Description	ID (hex)
<b>Digital Input Module</b>			
01	RIO3-XDP8	8 Points, Universal, 24Vdc, 10RTB	1238
02	RIO3-XDP16C	16 Points, Universal, 24Vdc, 20P connector	123F
03	RIO3-XDP16T	16 Points, Universal, 24Vdc, 18RTB	12DF
04	RIO3-XDP32C	32 Points, Universal, 24Vdc, 40P connector	12FA
05	RIO3-XY16T	8 Sink Input / 8 Source Output with Diagnostic, 24Vdc	1428
06	RIO3-XAH4	4 Points, 240Vac, 10RTB	1904
<b>Digital Output Module</b>			
07	RIO3-YTP8	8 Points, Source, 24Vdc/0.5A, 10RTB	2328
08	RIO3-YTP16C	16 Points, Source, 24Vdc/0.3A, 20P connector	222F
09	RIO3-YTP16T	16 Points, Source, 24Vdc/0.3A, 18RTB	226F
10	RIO3-YTP32C	32 Points, Source, 24Vdc/0.3A, 40P connector	22CA
11	RIO3-YS4	4 Points, MOS Relay, 240Vdc/ac, 0.5A, 10RTB	2734
12	RIO3-YS8	8 Points, MOS Relay Output Terminal, 240Vdc, 0.5A	2738
13	RIO3-YR4	4 Points, Relay, 24Vdc/2A, 240Vac/2A, 10RTB	2744
<b>Analog Input Module</b>			
14	RIO3-LDC2	2ch load cell input unit, strain gauge	3002
15	RIO3-AX4I	4 Channels, 0~20, 4~20mA, 12bits, 10RTB	3114
16	RIO3-AXH4I	4 Channels, 0~20, 4~20mA, 16bits, 10RTB	3154
17	RIO3-AX8I	8 Channels, 0~20, 4~20mA, 12bits, 10RTB	3118
18	RIO3-AXH8I	8 Channels, 0~20, 4~20mA, 16bits, 10RTB	3158
19	RIO3-AX16IC	16 Channels, 0~20, 4~20mA, 12bits, 20P connector	311F
20	RIO3-AX16IT	16 Channels, 0~20, 4~20mA, 12bits, 18RTB	317F
21	RIO3-AX4V	4 Channels, 0~10, 0~5, 1~5Vdc, 12bits, 10RTB	3424
22	RIO3-AXH4V	4 Channels, 0~10, 0~5, 1~5Vdc, 16bits, 10RTB	3464
23	RIO3-AX8V	8 Channels, 0~10, 0~5, 1~5Vdc, 12bits, 10RTB	3428
24	RIO3-AXH8V	8 Channels, 0~10, 0~5, 1~5Vdc, 16bits, 10RTB	3468
25	RIO3-AX16VC	16 Channels, 0~10, 0~5, 1~5Vdc, 12bits, 20P connector	342F
26	RIO3-AX16VT	16 Channels, 0~10, 0~5, 1~5Vdc, 12bits, 18RTB	347F
27	RIO3-RTD4T	4 Channels, RTD, 10RTB	3704
28	RIO3-RTD8C	8 Channels, RTD, 20P connector	3708
29	RIO3-TC4T	4 Channels, Thermocouple, 10RTB	3804
30	RIO3-E3AC	AC Measurement	3901
<b>Analog Output Module</b>			
31	RIO3-AY4I	4 Channels, Current Output, 4~20mA, 12bits	4214

32	RIO3-AYH4I	4 Channels, Current Output, 4~20mA, 16bits	4254
33	RIO3-AY8I	8 CHANNELS CURRENT OUTPUT, 4~20mA, 12BIT	4218
34	RIO3-AY4V	4CH, 0~10Vdc, 12Bits, 10RTB	4424
35	RIO3-AYH4V	4CH, 0~10Vdc, 16Bits, 10RTB	4464
36	RIO3-AY8V	8CH, 0~10Vdc, 12Bits, 10RTB	4428
37	RIO3-AY16VC	16CH, 0~10Vdc, 12Bits, 20P Connector	442F
38	RIO3-AY16VT	16CH, 0~10Vdc, 12Bits, 18RTB	447F
<b>Special Module</b>			
39	RIO3-CU24L	High Speed Counter, 2CHs, 24Vdc, Encoder Input, 10RTB	
40	RIO3-RS232	1CH, RS 232, RTS/CTS, Full Duplex Type, 10RTB	5211
41	RIO3-RS485	1CH, RS 485, Half Full Duplex Type, 10RTB	5231
42	RIO3-PWM2	PWM Output, 2CHs, 0.5A/24Vdc, Source, 18RTB	5442
43	RIO3-PO2	Pulse Output, 2CHs, 0.5A/24Vdc, Source, 18RTB	5642
<b>Power Module</b>			
44	RIO3-SHD	Shield Module	7408
45	RIO3-0VDC	Common for 0Vdc	7508
46	RIO3-PSD	Power Expansion, In 24Vdc, Out 1A/5Vdc	7511
47	RIO3-24VDC	Common for 24Vdc	7518
48	RIO3-VDC	Common for 0Vdc, 24Vdc	7588
49	RIO3-PS	Field Power, 5/24/48 Vdc, 110/220 Vac	7641

## 7.2 Glossary

System Power: The power for starting up CPU.

Field Power: The power for input and output line.

Terminator Resistor: Resistor for prevention reflected wave.

EDS: Electronic Data Sheet.

Sink: The method of in/output power supply if a device has no power source.

Source: The method of in/output power supply if a device has the power source.